

PAVA9008 / PAVA9008E

Remote Paging Microphone / Expansion Keyboard



Description

EN54-16 fire emergency broadcasting system provides manual operation and timing programming, and gives priority to the former over the latter; supports real-time monitoring of equipment operating status and recording of operating logs. It meets the relevant standard of “EN54-16 Voice Alarm Control and Indicating Equipment”. The broadcasting system can be used for fire emergency broadcasting, daily service broadcasting and background broadcasting; this system is positioned as a small emergency broadcasting system, mainly used in small shopping malls, small office buildings and exhibition halls, etc.

PAVA9008/PAVA9008E Remote Paging Microphone / Expansion Keyboard is used to page each zone of the host PAVA9500.

Features

- Support 16-zone paging, single- or multi-zone paging, group paging and all-zone paging.
- With DIP address settings.
- Powered by bus and DC48V.
- With 1 AUX IN for paging signal input.
- With 2-digit DIP switches for selecting AUX or Local MIC IN.
- Support redundant wiring of lines.
- The system can support up to 8 devices (remote paging microphones or fireman microphones). With RJ45 ports, these microphones are powered by bus communication port and connected hand in hand.
- Support self-defined group functions for buttons.
- If the host is connected to a device via a single port, it can support a maximum transmission distance of 600 meters. The host can be cascaded to up to three devices via a single port, with a maximum transmission distance of 300 meters.

Specifications

Model	PAVA9008	PAVA9008E
Microphone Input Sensitivity	30mV 600Ω	---
Line Input Sensitivity	1000mV 10kΩ	---
Frequency Response	80Hz~15kHz (±3dB)	---
Distortion	<1%	---
S/N Ratio	>75dB (A-Weighted)	---
PoE Power	(48±3)V/0.1A	---
Phantom Power	---	(12~24)V/0.1A
Interface		RJ45
Package Dimensions	415×306×116mm	355×266×116mm
Machine Dimensions	166×220×54mm	166×161×54mm
Gross Weight	1.7kg	1.3kg
Net Weight	1.25kg	0.8kg

Front / Rear Panel

Front Panel

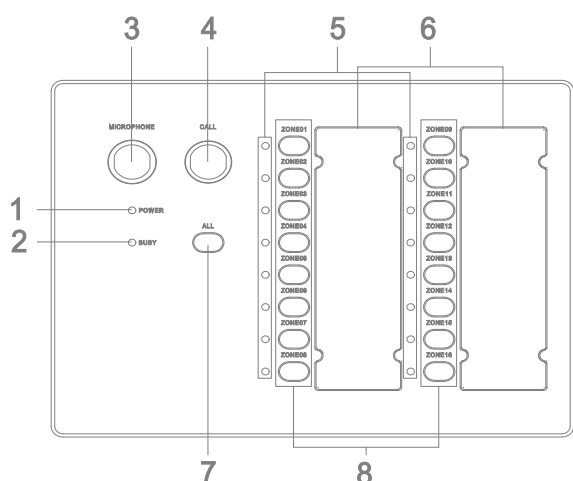

PAVA9008 Remote Paging Microphone

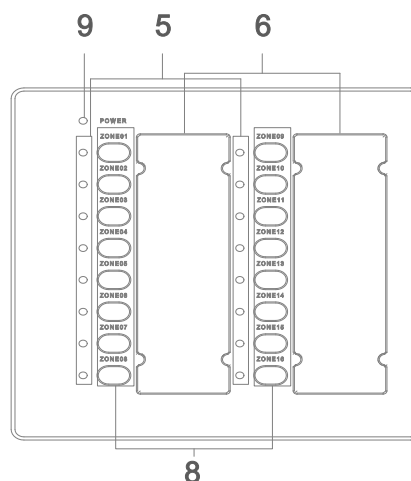

PAVA9008E Expansion Keyboard

1—Power Indicator

- ◆ On - Indicates that the device is powered normally.
- ◆ Off - Indicates abnormal power supply.

2—Equipment “Busy” Indicator

- ◆ When the indicator light is on, the equipment is busy, and please wait.

3—Microphone Rod Connector

- ◆ When the LED indicator of the microphone is red, it indicates that it is allowed for paging.

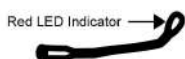

Note:

4—Paging Activation Button

- ◆ MIC paging control button.

Notes:

- ①. After selecting zones, press this button to start paging (speaking is allowed after the microphone indicator is on).
- ②. When paging, press this button to end the current paging.
- ③. When the MIC is working in PPT mode, it is required to keep pressing this button for paging, otherwise the paging will be ended (please refer to the instructions on the rear panel for PPT mode).
- ④. If no zones are selected, paging cannot be activated.

5—Zone/Group Selection and Working Status Indicator

- ◆ Green - The button function has been executed.
- ◆ Off - The button function has ended.
- ◆ Flashing - Indicates that the zone is currently selected by the user.

6—Remarks on Zone/Group Information

- ◆ The zone/group information remarked by the user, such as the current zone name and group number.

7—Select All Button

- ◆ When the MIC is not paging,
 - ①. If all zones are flashing, press this button to cancel the selected state of all zones.
 - ②. If only some of the zones are selected, press this button to select all zones, and press this button again to cancel the selected state of all zones.
- ◆ When the MIC is paging,
 - ①. When it is working in zone mode,
 - a. If all zones are normally on, press this button to cancel the selected state of all zones.
 - b. If only some of the zones are selected, press this button to select all zones, and at this time up to 16 zones can be selected.
 - ②. When it is working in group mode,
 - c. If all groups are normally on, press this button to cancel the selected state of all groups.
 - d. If only some of the groups are selected, press this button to select all groups, and at this time up to 16 groups can be selected.

8—Zone/Group Selection Button

- ◆ When the MIC is not currently paging and the LED indicator is off, press the corresponding button, and then the corresponding indicator light will be flashing, indicating that the corresponding zone is selected.
- ◆ When the MIC is currently paging and the LED indicator is normally on, press the corresponding button, and then the corresponding indicator light will go out, indicating that the corresponding zone is deactivated.

9—Power Indicator

Rear Panel

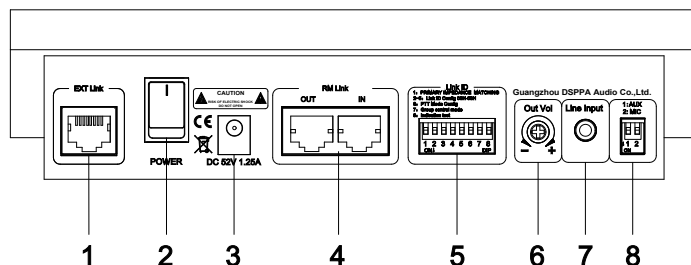

.PAVA9008 Remote Paging Microphone

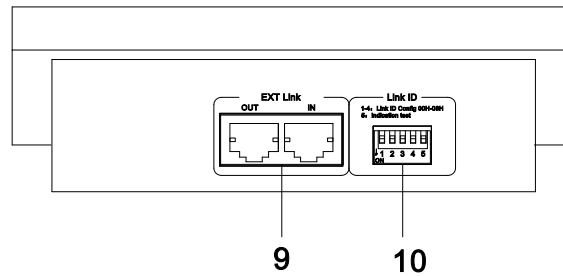

PAVA9008E Expansion Keyboard

1—Remote Paging Microphone Expansion Keyboard Connection Port

- ◆ Used to connect the remote paging microphone expansion keyboard to expand zone control; used for RS485 serial port communication.

2—Paging Microphone Power Switch

- ◆ Used to turn on or off the working power of the remote paging microphone / remote paging microphone expansion keyboard.
- ◆ The remote paging microphone expansion keyboard should be connected to PAVA9008 first, that is, the port “9” of the PAVA9008E should be connected to the port “4” of the PAVA9008.

3—DC24V Power Supply Interface

4—Powered Data Audio Bus Interfaces

With two RJ45 ports, the system can be connected to up to 8 devices (remote paging microphones and fireman microphones) hand in hand.

5—Equipment ID Configuration Switch

“1” is used to set the end matching resistance, dialed down for enabled.

“2~5” indicate the IDs for device connection. The following devices are connected with the IDs as shown below (that is, the binary value of the device ID2~5, dialed down for “1”, dialed up for “0”). Note: The silk screen printing “2” on the DIP switch is the highest binary bit, and “5” is the lowest binary bit. For the correspondence between the device address order and the binary value, please refer to the “Attached Table: Comparison Table of Zone Address and Dialing Code Settings”.

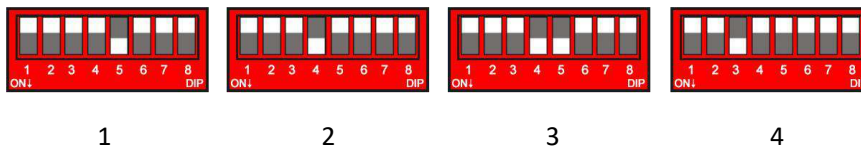

If “6” is dialed up, the MIC will be working in normal mode; if dialed down, the MIC will be working in PPT mode, in which the “Paging Activation Button” should be pressed all the time for paging broadcasting.

“7” is the group mode switch. If it is dialed down, the remote paging microphone will be in group mode; if not, it will be in zone mode.

“8” is used to test the “LED” indicators on the panel of the remote paging microphone (it is dialed up normally). If it is dialed down, all the “LED” indicators on the panel will be lit up “Red”→“Green”→“Yellow” once and then automatically return to the normal display state, which is mainly used to test whether the “LED” indicators are normal.

6—Remote Paging Microphone Output Audio Sensitivity Control

7—MIC External Line Audio Input Interface

The audio from this interface shares the same output channel with the audio from the item “3” on the front panel, and the audio from the item “3” has priority over Line. Please note that it is a 3.5 audio interface.

8—Audio Selection DIP Configuration Switch (Down for “Enabled”, Up for “Disabled”)

- ◆ “1” is used to enable the line input.
- ◆ “2” is used to enable the local microphone.
- ◆ Dialed down for enabled. When “1” and “2” are dialed down, the audio will be mixed for output, and when

dialed down simultaneously, both will be closed.

9—Equipment Connection Port

◆ Used to connect the remote paging microphone PAVA9008 or the previous/next expansion keyboard PAVA9008E.

Note: When it is used to connect the expansion keyboard PAVA9008E, there is no primary or secondary difference between these two ports, and one PAVA9008 can be connected to up to 8 PAVA9008E.

10—Equipment ID Configuration Switch

“1~4” indicate the IDs for device connection. The following devices are connected with the IDs as shown below (that is, the binary value of the device ID1~4, dialed down for “1”, dialed up for “0”). , Note: The silk screen printing “1” on the DIP switch is the highest binary bit, and “4” is the lowest binary bit. For the correspondence between the device address order and the binary value, please refer to the “Attached Table: Comparison Table of Zone Address and Dialing Code Settings”.

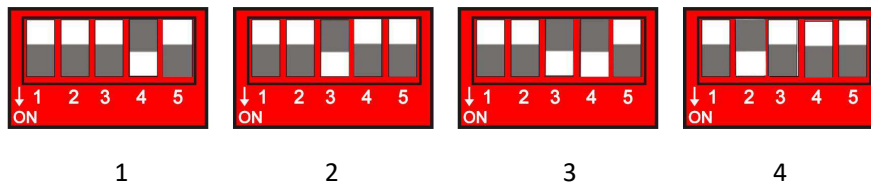

“5” is used to test the “LED” indicators on the panel of the remote paging microphone expansion keyboard (it is dialed up normally). If it is dialed down, all the “LED” indicators on the panel will be lit up “Red”→“Green”→“Yellow” once and then automatically return to the normal display state, which is mainly used to test whether the “LED” indicators are normal.